



Doorphone & Interphone

With easier installation and convenience in use, KOCOM Doorphone & Interphone secure the highest communication quality.

Based on automated state-of-the-art production facility, KOCOM develops and produces reliable interphone and doorphone products with the highest communication quality and supplies them to domestic as well as overseas markets.

KOCOM provides a variety of product sets suitable to installation sites (for example, home, store or office) according to its functions and purposes. Consumers can easily install and conveniently use them.



Multiple Doorphone

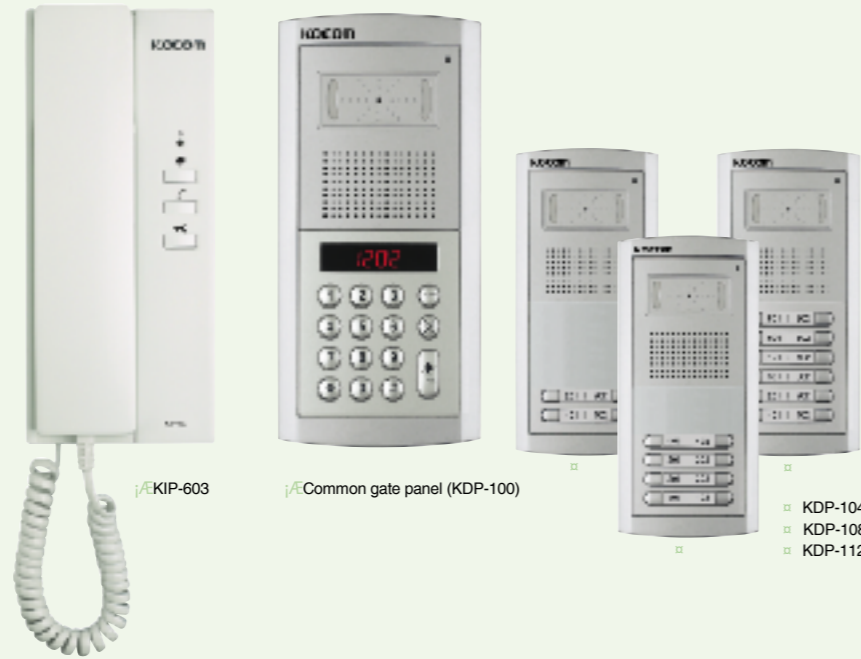

KIP-603

Common gate panel (KDP-100)

KDP-104
KDP-108
KDP-112

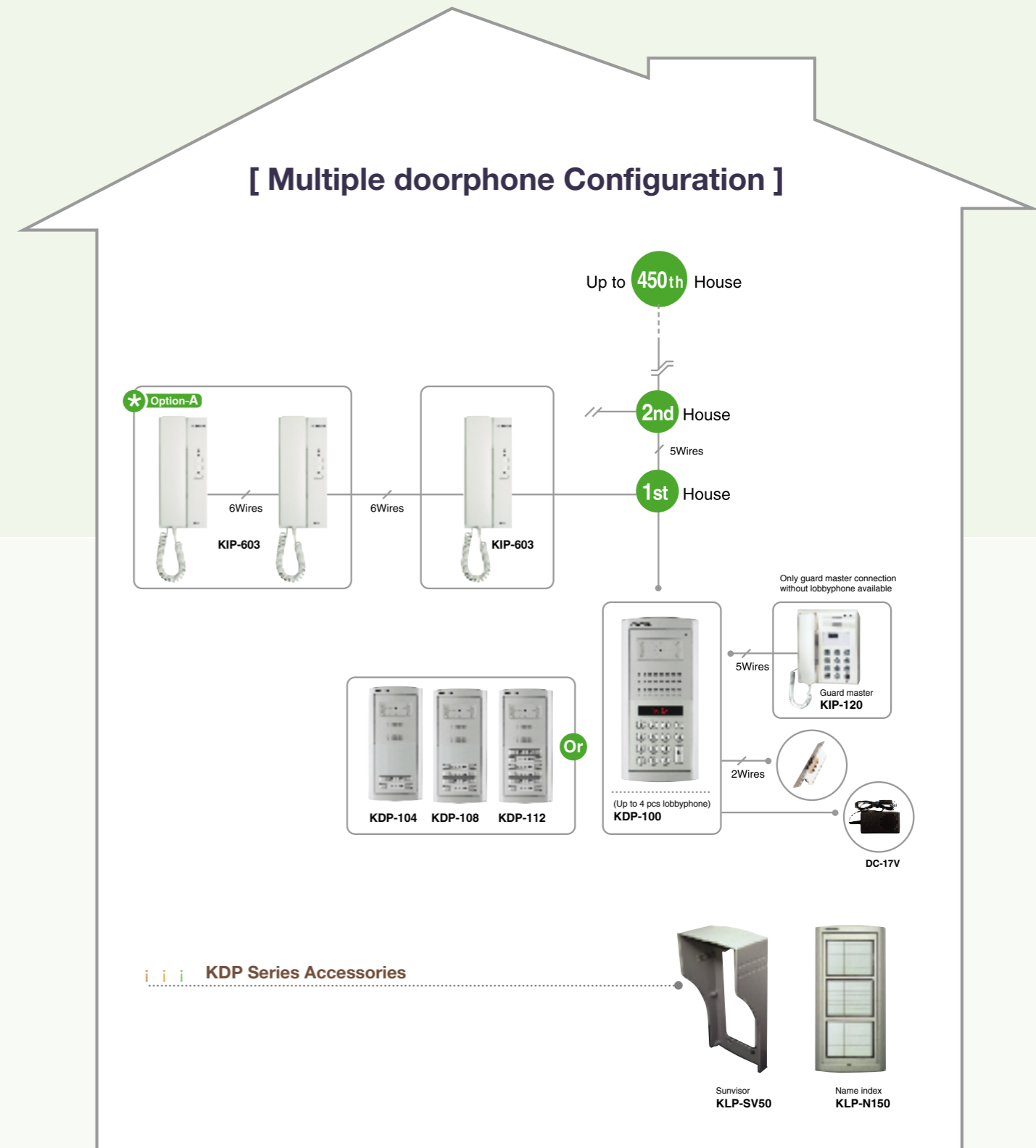

Dimension

[KIP-603]

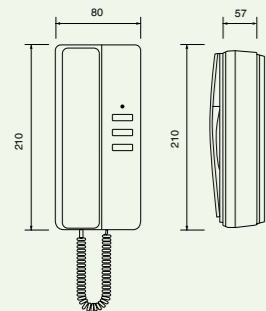

[KIP-120]

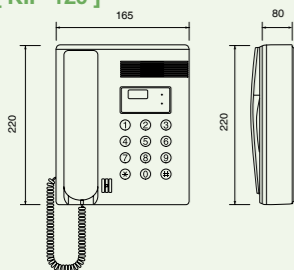

[KDP-100]

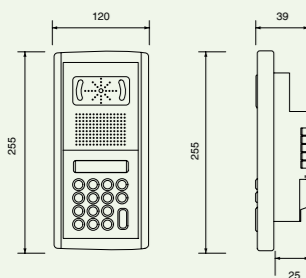

[KIP-603]

- For multi apartment, condominium & villa system, upto 450 houses are available
- Up to 3 indoor extension in a house
- Internal call & conversation function between extended indoor units in a house
- Audio conversation with visitor
- Door open (common gate) function
- Call & conversation function with guard master (KIP-120)

[KIP-120]

- Call & conversation function with resident & extended KIP-120 (Up to 3pcs in a system)
- Conversation with visitor (KDP-100, KLP-100 series) & door open

[KDP-100 / KDP-104, KDP-108, KDP-112]

- Upto 4 houses (KDP-104), upto 8 houses (KDP-108), upto 12 houses (KDP-112)
- Upto 450 houses connection (KDP-100)
- Communication with guard master (KDP-100)
- Door open function by access code (KDP-100)
- Firm metal body case with new modern design
- Upto 4pcs of common gate panels connection in a building

Specifications

Model no.	KIP-603	KIP-120	KDP-100 / 104 / 108 / 112
Power	DC 17V (±1V) powered from common power supply		
Power consumption	Max. 5W, Stand by 2W		
Assurance temperature	0°C~+50°C		-20°C~+50°C
Wiring	5wires (common wiring)		
Max. wiring distance	□0.8 single cable : 300m, 5C-2V coaxial cable : 500m		
Mount type	Surface mount		Flush mount
Dimension (mm)	92(W) x 210(H) x 57(D)	165(W) x 220(H) x 80(D)	120(W) x 255(H) x 39(D)
Weight (Approx.)	0.5kg	1.0kg	1.0kg

The product may include option or additional functions.

KDP Series Accessories



Multiple Doorphone



KDP-205



KLP-1000



DP-203HA



KDP-601A



Diagram

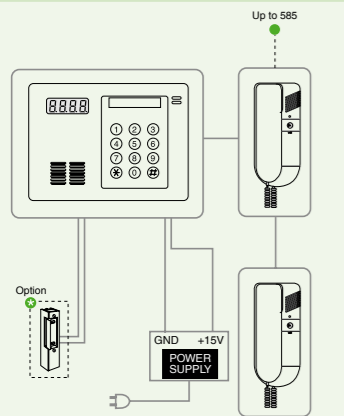

[KDP-205]

- For multi apartment, condominium & villa system, upto 585 houses are available
- Audio conversation with visitor
- Door open (common gate) function
- Call & conversation function with guard (KLP-1000)

[KLP-1000]

- Door open function by access code
- Firm metal body case with new modern design
- Upto 2pcs of common gate panel connection in a building



[Power Supply]

- PS-M2 (15V)
- Input : AC 100V~130V or 220V~240V
- Output : DC 16.5V / 1A_i 2V

Dimension

[KDP-100]

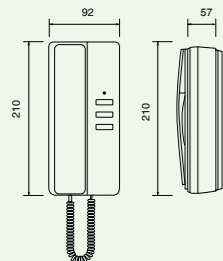

[KDP-100]

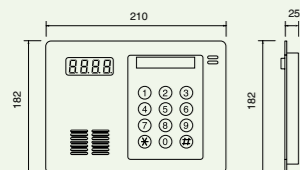

Specifications

Model no.	KDP-205	KLP-1000
Power	DC 15V (1V) powered from common power supply	
Power consumption	Max. 0.2W, Stand by 0W	Max. 3W, Stand by 0.3W
Assurance temperature	0°C~+50°C	-20°C~+50°C
Wiring	3wires (common wiring)	
Max. wiring distance	Ø0.8 single cable : 300m, 5C-2V coaxial cable : 500m	
Mount type	Surface & Flush mount	
Dimension (mm)	92(W) x 210(H) x 57(D)	210(W) x 182(H) x 25(D)
Weight (Approx.)	0.5kg	1.0kg

The product may include option or additional functions.

[DP-203HA / KDP-601A]

- Upto 4 houses connection
- Audio conversation with visitor
- Door open (common gate) function
- Gentle electronic sound
- Easy installation (mount on the wall or desk)

[MSD-1B, MSD-2B, MSD-3B, MSD-4B, KC-MD12/14]

- Aluminum common gate panel
- 1 house (MSD-1B)
- Upto 2 house (MSD-2B)
- Upto 3 house (MSD-3B)
- Upto 4 house (MSD-4B)
- Rain proof, metal anti vandal
- Flush & surface mounting
- Upto 2 house (KC-MD12)
- Upto 4 house (KC-MD14)



Specifications

Model no.	DP-203HA, KDP-601A
Power	AC110V or AC220V (± 10%)
Power consumption	Max. 30mA
Assurance temperature	0°C~+50°C
Wiring	2wires
Max. wiring distance	Ø0.65 single cable : 300m, 5C-2V coaxial cable : 500m
Mount type	Surface mount
Dimension (mm)	92(W) x 210(H) x 57(D)
Weight (Approx.)	0.5kg

The product may include option or additional functions.

Diagram

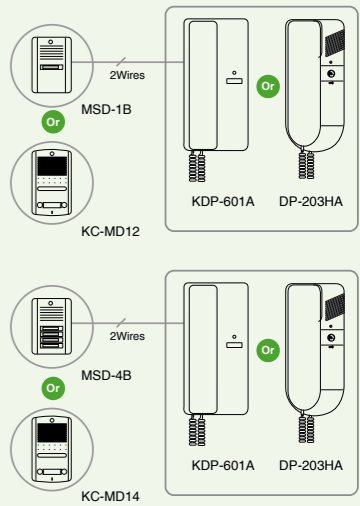

Dimension

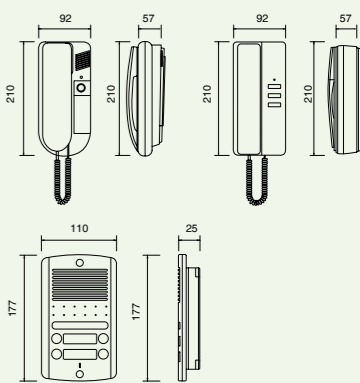



Multiple Interphone



Diagram

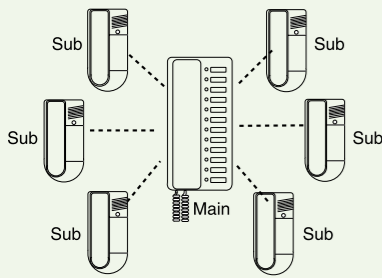

Dimension

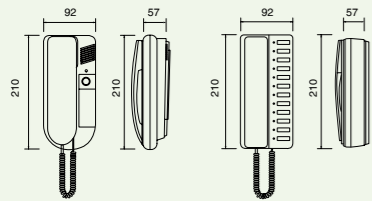

[Power Supply]
 ■ PS-M1
 -Input : AC 100V~127V or 220V~240V
 -Output : DC 24V / 1.2A

[KIP-612MBL / IP-200PC]

- 12Ch Multiple interphone
- Master & sub phone system
- Master : KIP-612MBL
- Sub : IP-200PC
- Gentle electronic sound
- Easy wiring & installation (mount on the wall or desk)

Specifications

Model no.	KIP-612MBL	IP-200PC
Power	DC24V / 1.2A (powered from common power supply)	
Power consumption	Max. 70mA	
Assurance temperature	0°C~+50°C	
Wiring	2wires	
Max. wiring distance	∅0.65 single cable : 1Km	
Mount type	Surface mount	
Dimension (mm)	92(W) x 210(H) x 57(D)	
Weight (Approx.)	0.5kg (1pc)	

The product may include option or additional functions.

[KIP-611PG / KIP-605PG]

- 5 Ch multiple interphone : KIP-605PG
- 11 Ch multiple interphone : KIP-611PG
- Single or multiple connection
- All master intercom system
- Paging function
- Gentle electronic sound
- Easy wiring & installation (mount on the wall or desk)
- Outdoor panel, DS-4M connection

Specifications

Model no.	KIP-605PG	KIP-611PG	DS-4M
Power	DC24V / 1.2A (powered from common power supply)		
Power consumption	Max. 1.7W, Stand by : 0.85W		
Assurance temperature	0°C~+50°C		
Wiring	4wires		
Max. wiring distance	∅0.65 single cable : 1Km		
Mount type	Surface mount		
Dimension (mm)	92(W) x 210(H) x 57(D)		95(W) x 127(H) x 32(D)
Weight (Approx.)	0.5kg (1pc)		

The product may include option or additional functions.

Diagram

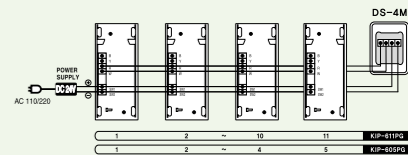

Dimension

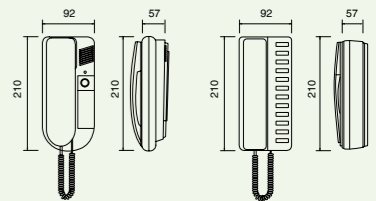

[Power Supply]
 ■ PS-M1
 -Input : AC 100V~127V or 220V~240V
 -Output : DC 24V / 1.2A



[Outdoor Panel]
 ■ DS-4M



Doorphone & Interphone



Diagram

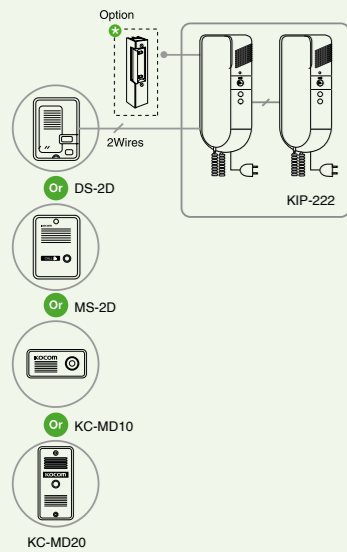

Dimension

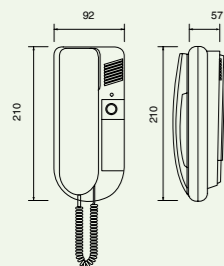

[KIP-222]

- Duplex interphone & doorphone
- Audio conversation with visitor
- Door open function
- Internal call & conversation with extended units
- Gentle electronic sound (separate call sound)
- Easy installation (mount on the wall or desk)

Specifications

Model no.	KIP-222
Power	AC110V or AC220V (± 10%)
Power consumption	Max. 30mA
Assurance temperature	0°C~+50°C
Wiring & call sound	Door : 2wires, Chime Audio handset : 4wires, Melody
Max. wiring distance	∅ 0.65 single cable : 300m, 5C-2V coaxial cable : 500m
Mount type	Surface mount
Dimension (mm)	92(W) x 210(H) x 57(D)
Weight (Approx.)	0.5kg (1pc)

The product may include option or additional functions.

[KDP-602A/D]

- Triplex interphone & doorphone
- Upto 3 audio handset with 1 outdoor panel connection
- Audio conversation with visitor
- Door open function
- Internal call & conversation with extended units
- Gentle electronic sound (separate call sound)
- Easy installation (mount on the wall or desk)

Specifications

Model no.	KDP-602A/D
Power	AC110V or AC220V (± 10%)
Power consumption	Max. 150mA
Assurance temperature	0°C~+50°C
Wiring & call sound	Door : 2wires, Chime Audio handset : 5wires, Melody
Max. wiring distance	∅ 0.65 single cable : 300m, 5C-2V coaxial cable : 500m
Mount type	Surface mount
Dimension (mm)	92(W) x 210(H) x 57(D)
Weight (Approx.)	0.5kg (1pc)

The product may include option or additional functions.

Diagram

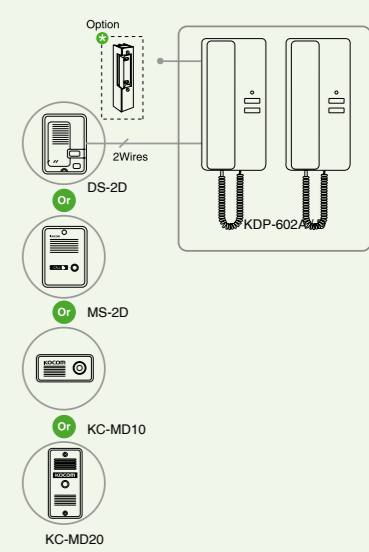

Dimension

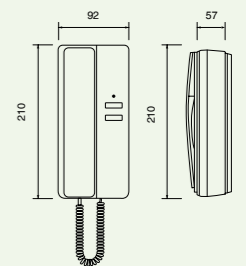



Doorphone & Interphone



Diagram

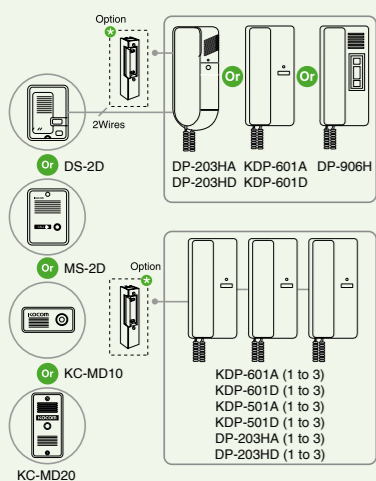

Dimension

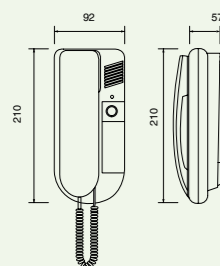

[DP-203HA / HD] [KDP-501A/501D / KDP-601A / 601D / DP-906H]

- Audio conversation with visitor
- Door open function
- Upto 3 audio handset with outdoor panel connection (DP-203HA, DP-203HD, KDP-501A, KDP-501D, KDP-601A, KDP-601D)
- Gentle electronic sound
- 4 melody selection (DP-906H)
- Easy installation (mount on the wall or desk)
- DC 12V Type available : DP-203HD (DC 12V)

Specifications

Model no.	DP-203HA, KDP-601A KDP-501A	DP-906H	DP-203HD (DC12V)	DP-203HD, KDP-601D KDP-501D
Power	AC110V or AC220V (± 10%)		DC12V	DC6V (AA 1.5V battery) x 4ea
Power consumption	Max. 150mA			
Assurance temperature	0°C~+50°C			
Wiring	2wires			
Max. wiring distance	∅ 0.65 single cable : 300m, 5C-2V coaxial cable : 500m			
Mount type	Surface mount			
Dimension (mm)	92(W) x 210(H) x 57(D)			
Weight (Approx.)	0.5kg (1pc)			

The product may include option or additional functions.

[IP-201P / KIP-501P / KIP-601P]

- Duplex interphone
- Gentle electronic sound
- Easy wiring & installation (mount on the wall or desk)

Specifications

Model no.	IP-201P	KIP-501P	KIP-601P	KIP-501D
Power	DC6V (AA 1.5V battery) x 4ea			
Power consumption	Max. 150mA			
Assurance temperature	0°C~+50°C			
Wiring	2wires			
Max. wiring distance	∅ 0.65 single cable : 300m, 5C-2V coaxial cable : 500m			
Mount type	Surface mount			
Dimension (mm)	92(W) x 210(H) x 57(D)			
Weight (Approx.)	0.4kg (1pc)			

The product may include option or additional functions.

Diagram

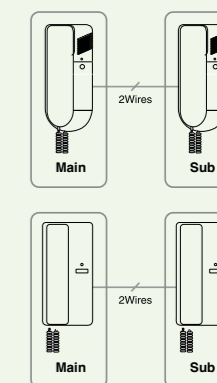

Dimension

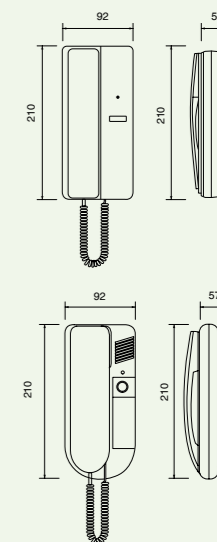



[KIC-301/304/308 (1CH/4CH/8CH) /300S (Sub)]



KIC-301



KIC-304

KIC-308

KIC-300S (Sub)

Diagram

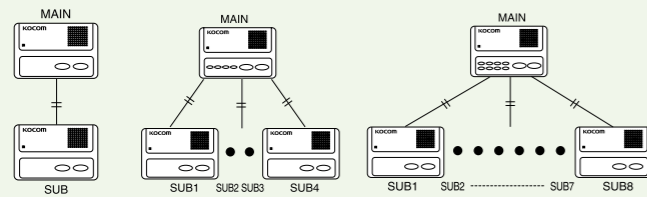

KIC-301

KIC-304

KIC-308

- Perfect conversation
- Delightful signal sound
- LED Indicator for call line
- Easily 2 wiring of polarity
- Power supply one side one used D.C 6V
- Easily mounted on wall, desk
- KIC-300S (Sub for 1CH, 4CH and 8CH)





Specifications

Model no.	KIC-301 / KIC-304 / KIC-308	KIC-300S
Power	DC 6V (LR6-AA 1.5V X 4)	Powered from main
Consumption	In use 30mA / Signal 150mA	
Signal sound	Electronic	
No. of wires	2 wires(polarity)	
Range	200m (∅0.65mm)	







The product may include option or additional functions.

[Outdoor Panel Series]

Multi House Series

Model no.	MSD-2B	MSD-3B	MSD-4B	KC-MD12	KC-MD14
					
Power	Powered from audio handset				
Assurance temperature	-20°C ~ +50°C				
Body material	Aluminum			Metal	
Mount type	Flush mount			Surface & Flush	
Dimension (mm)	122(W) x 199(H) x 35(D)			132(W) x 197(H) x 25(D)	
Weight (Approx.)	0.6kg			1kg	
Audio handset					
Connection	DP-203HA / DP-203HD / KDP-601A / KDP-601D / DP-906H / KIP-222 / KDP-602A/D				

Single House Series

Model no.	MSD-1B	DS-2D	MS-2D(S)	MS-2D(B)	KC-MD10	KC-MD20
						
Power	Powered from audio handset					
Assurance temperature	-20°C ~ +50°C					
Body material	Aluminum	Plastic	Metal			
Mount type	Flush mount		Surface mount			Flush & Surface mount
Dimension (mm)	122(W) x 199(H) x 35(D)		95(W) x 127(H) x 32(D)		77(W) x 38(H) x 18(D)	67(W) x 145(H) x 20(D)
Weight (Approx.)	0.6kg	0.5kg	0.6kg		0.3kg	0.5kg
Audio handset						
Connection	DP-203HA / DP-203HD / DP-203HD (DC 12V) / KDP-501A / KDP-501D / KDP-601A / KDP-601D / DP-906H / KIP-222 / KDP-602A/D					











Products Line Up

Home Network System Products		Home Network Type I High-end Home Network Solution	06 page
		Home Network Type II General Home Network Solution	08 page
		KHN-880 Series Wall-pad 10" TFT LCD Touch Screen	10 page
		KHN-870 Series Wall-pad 7" TFT LCD Touch Screen	12 page
		KHN-671 Series Wall-pad 7" TFT LCD Touch Screen	14 page
		KGW-1000 IP Broadcasting Home Gateway	16 page
		KHG-1000 Smart Home Gateway	17 page
	Multiple type		KSP-230 Sub Phone
		Security Sensor Gas leakage sensor Motion sensor Fire sensor Burglar sensor	19 page
		KWP-1000 Remote Controller 900MHz Wireless Telephone	20~21 page
		KTD-505 7" Kitchen TV Phone KTD-510 5" Kitchen TV Phone	22 page
Common Gate Camera		KC-C70 Door camera	23 page
		KBP-100 / 105 Bathroom Phone	

Home Network System Products		KLP-305 Lobby Phone	24~25 page
		KHU-305 Integrated Access Device	
		KAM-305 Guard Office Master	25 page
Color Hands Free		System Diagram Products	26 page
		KHV-478 7" DSP Hands Free Type	30 page
		KHV-458 5" DSP Hands Free Type	
		KHV-456S DSP Hands Free Type	32 page
Multiple type		KCV-356 Smart Home Gateway	34 page
		KIV-202 / D202 Hands Free Type	36 page
		KIV-102 / D102 Hands Free Type	37 page
Common Gate Camera		KVM-520 4" CRT B/W VDP monitor	38 page
		KLP-C100 / KLP-C104 KLP-C108 / KLP-C112 (Color) KLP-100 / KLP-104 / KLP-108 KLP-112 / KLP-P100 / KLP-P104 KLP-P108 / KLP-P112 (B/W)	40 page
Common Gate Camera		KLP-304 / 308 / 312 KLP-P304 / P308 / P312 B/W Normal Lens type Pinhole Lens type	42 page
		KC-MC12 / 14 / KC-MB12 / 14 Pinhole Lens type	43 page

Handfree type		KCV-350 / D350 Color Hands Free Type Phone	44 page
		KIV-101 B/W Hands Free Type Phone	
Memory & B/W type		KVM-534 Memory Type Phone	46 page
		KVR-500 External memory equipment	47 page
		KDP-602G Extension sub doorphone	
Memory & B/W type		KVM-524RG / 514RG Memory Type Phone	48 page
		KVM-524GS / 514GS Memory Type Phone	49 page
B/W type		KVM-604 4" CRT B/W VDP	50 page
		KVM-624 4" CRT B/W VDP	51 page
Door Camera Series		Door Camera Series Color Camera Series B/W Camera Series	52 page
		KDL-T1 I-Button Key Type KDL-C1 RF Card Type KDL-F1 Finger Print Type	54 page

Multiple Doorphone		KIP-603 / KIP-120 / KDP-100 KDP-104, KDP-108, KDP-112 Multiple Doorphone	58 page
		KDP-205 / KLP-1000 DP-203HA / KDP-601A Multiple Doorphone MSD-1B / MSD-2B / MSD-3B / MSD-4B Aluminum outdoor panel KC-MD12 / 14 Metal anti vandal proof	60~61 page
Doorphone & Interphone		KIP-222 Duplex interphone & doorphone	62 page
		KDP-602A / D Doorphone	63 page
		DP-203HA / HD KDP-501A / 501D KDP-601A / 601D DP-906H	64 page
Multiple Interphone		IP-201P / KIP-501P KIP-601P Duplex interphone	65 page
		KIP-612MBL / IP-200PC Multiple Interphone KIP-611PG / KIP-605PG Multiple Interphone	66 page 67 page
Intercom & Outdoor Panel		KIC-301 / 304 / 308 (1CH / 4CH / 8CH) 300S (Sub) Intercom	68 page
		Outdoor Panel Series Multi House Series Single House Series	69 page